

EMC Components

ZJSR Series

3-Terminal Filters for Signal Line and DC Power Line Lead(Round)

FEATURES

- The ZJSR series combine TDK's high performance ferrite bead and a chip capacitor. This board mounted EMC filter is used to prevent microcomputer operational errors and stop noise generation. Most suitable for use in countering radio noise generated by digital circuits.
- SIP shape with 2.4mm max. thickness, making possible high density mounting upon a PCB in a row at DIP pitch.
- When using taped product, possible to mount using automatic equipment.
- Excellent high frequency bypass performance due to short earth-side capacitor lead.

PRODUCT IDENTIFICATION

ZJSR5101 - 101 TA

(1) (2) (3)

(1)Series name

(2)Capacitance 101:100pF

(3)Packaging style TA: Taping

(not needed for specification of bulk products)

SHAPES AND DIMENSIONS

TAPING SPECIFICATIONS

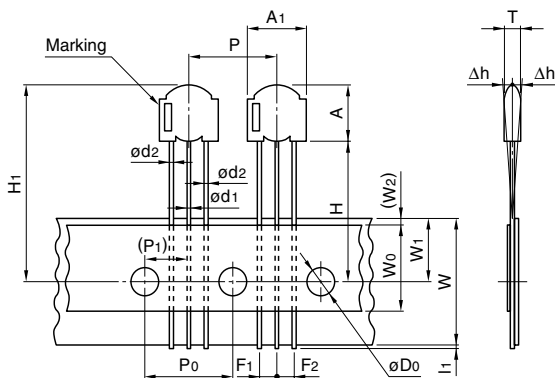

BULK SPECIFICATIONS

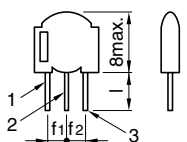

CIRCUIT DIAGRAM

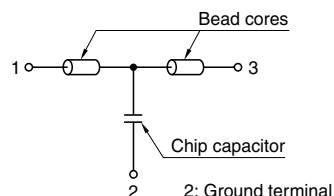

TYPICAL MOUNTING EXAMPLE

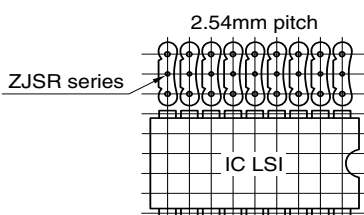

APPLICATIONS

Home electronic equipment, (TVs, VCRs, CD players, DAT players, electric musical instruments, PCs, etc.), office automation equipment (computers, terminals, stand-alone word processors, fax machines, etc.), factory automation equipment (robots, numerical control devices, process controllers, etc.), automotive electronics (automotive engine control units, etc.)

BASIC CHARACTERISTICS

Series	ZJSR
Rated voltage E _{dc}	50V
Rated current	5A
Withstand voltage E _{dc} [Between terminal, No.1, 3 to 2]	125V
Insulation resistance [DC. 50V for 1 min]	10000MΩ min.
DC resistance[Terminal No.1 to 3]	0.05Ω max.
Operating temperature range	-25 to +85°C

- This product should not be used under conditions that exceed those listed above.
- Please note that this product is an EMC filter, so should not be used as a surge absorber, etc.

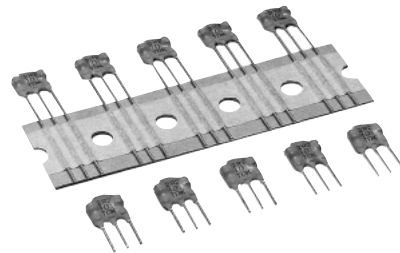

Dimensions in mm

Series	ZJSR
Component width	A ₁ 8.5max.
Component height	A 8max.
Component thickness	T 2.4max.
Lead wire diameter (round)	ød ₁ 0.5±0.05 ød ₂ 0.6±0.05
Component pitch	P 12.7±1
Feed hole pitch	P ₀ 12.7±0.3
Feed hole position error	P ₁ 6.35±0.4
Lead pitch	F ₁ , F ₂ 2.5±0.4, -0.1
Component alignment	Δh 0±2
Tape width	W 18+1, -0.5
Cover tape width	W ₀ 12±0.3
Feed hole position error	W ₁ 9±0.5
Cover tape position	(W ₂) (4max.)
Component bottom position	H 20±1
Maximum component height	H ₁ 28max.
Feed hole diameter	øD ₀ 4±0.2
Lead wire protrusion	I ₁ 0.5max.
Lead wire length	l 5±1.5
Lead pitch	f ₁ , f ₂ 2.5±0.5

- The tolerance of lead pitch is the dimensions when a lead is released from tape. Not available for bulk packaging.

EMC Components

ZJSR Series

3-Terminal Filters for Signal Line and DC Power Line Lead(Round)

ELECTRICAL CHARACTERISTICS

Part No.	Capacitance (pF)	Tolerance (%)	Maximum attenuation (MHz)	Frequency range (MHz)[normal mode]*		Marking
				15dB min. attenuation	25dB min. attenuation	
ZJSR5101-330	33	±20	700	400 to 800	650 to 800	330
ZJSR5101-470	47	±20	600	350 to 800	550 to 700	470
ZJSR5101-680	68	±20	500	250 to 800	450 to 600	680
ZJSR5101-101	100	±20	400	200 to 800	350 to 500	101
ZJSR5101-221	220	±20	280	100 to 800	200 to 350	221
ZJSR5101-331	330	±20	220	70 to 800	150 to 300	331
ZJSR5101-102	1000	±20	140	30 to 800	70 to 200	102
ZJSR5101-222	2200	±20	80	20 to 800	45 to 200	222
ZJSR5101-332	3300	±20	70	15 to 800	35 to 200	332
ZJSR5101-472	4700	±20	60	10 to 800	25 to 200	472
ZJSR5101-682	6800	±20	50	8 to 800	20 to 200	682
ZJSR5101-103	10000	+80, -20	35	6 to 800	15 to 200	103
ZJSR5101-223	22000	+80, -20	27	4 to 800	9 to 200	223
ZJSR5101-333	33000	+80, -20	20	3 to 800	7 to 200	333

* Operating temperature range: +5 to +35°C

TYPICAL ELECTRICAL CHARACTERISTICS

ATTENUATION vs. FREQUENCY CHARACTERISTICS

Glass epoxy coated double side mounting PCB(t=1.6mm)

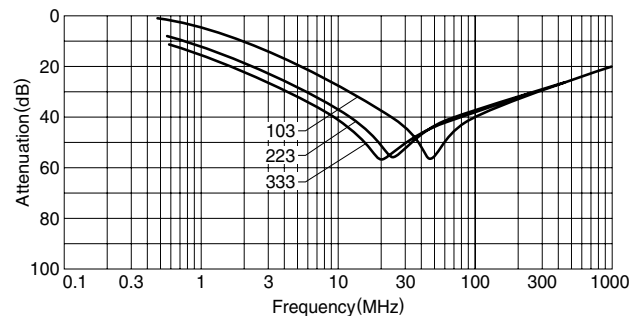
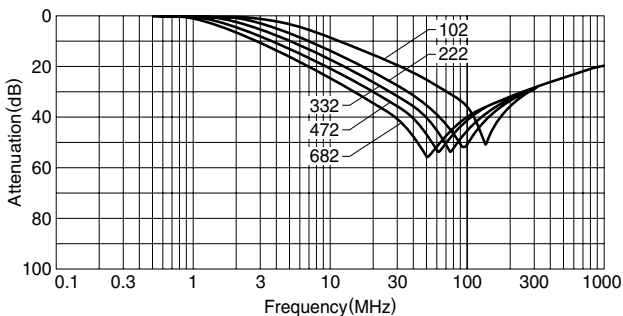
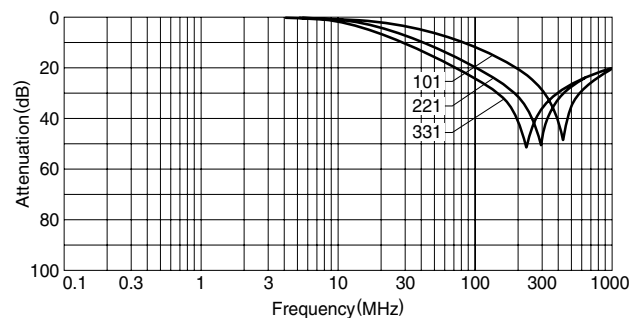
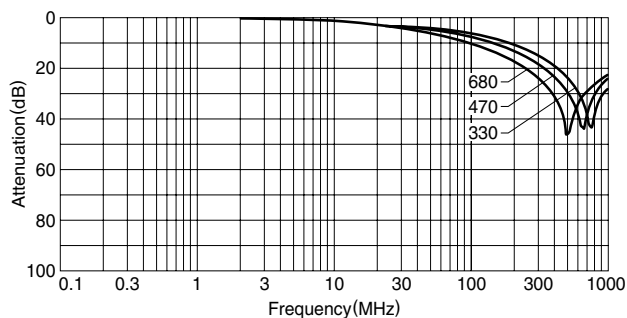

CIRCUIT DIAGRAM

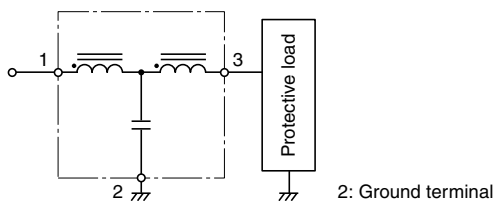

PACKAGING STYLE AND QUANTITIES

Packaging style	Quantity
Taping	2000 pieces/reel

PACKAGING STYLE (Ammo-pack)

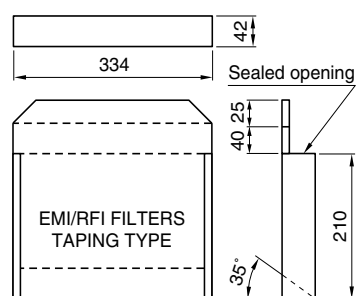

INDICATES INTERIOR CONTENTS OF BOX

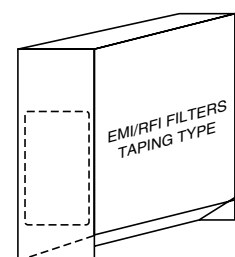

Dimensions in mm

EMC Components

ZJSR Series

3-Terminal Filters for Signal Line and DC Power Line Lead(Round)

TECHNICAL NOTES

INSERTION ATTENUATION MEASUREMENT METHOD

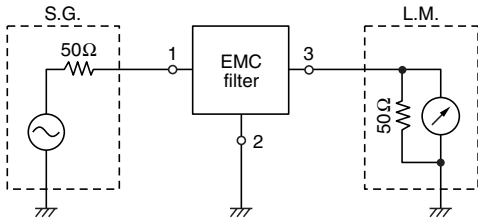

$$\text{Attenuation} = \log_{10} \frac{E_2}{E_1} \text{ (dB)}$$

E2: Set EMC filter in the circuit
E1: Leave EMC filter in the circuit

MOUNTING SUBSTRATE FOR MEASUREMENT

Mount on the glass fabric-backed epoxy resin double-sided through-hole substrate (t=1.6mm)

MEASUREMENT TEMPERATURE

+5 to +35°C

TYPICAL APPLICATIONS

An example of radiated noise suppressing circuit by connecting a PC and a printer.

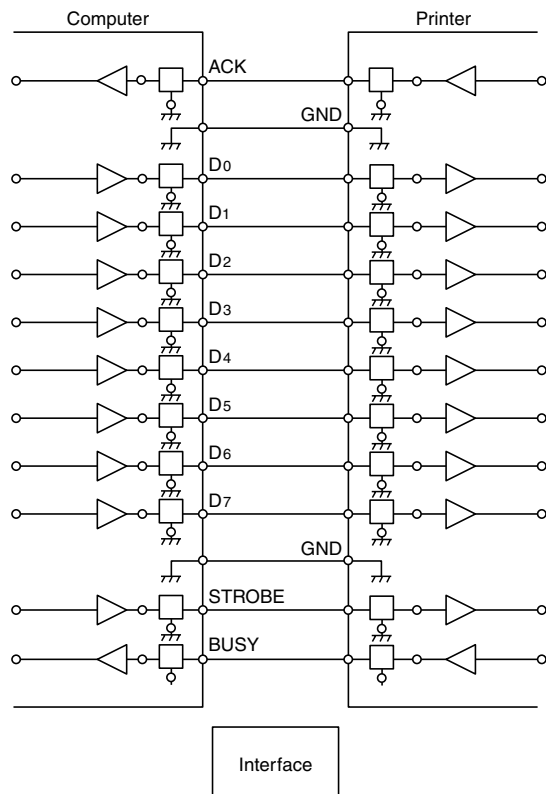

EXAMPLES OF MEASURING NOISE SUPPRESSION EFFECT (Waveform spectrum)

(1) MEASUREMENT CIRCUIT

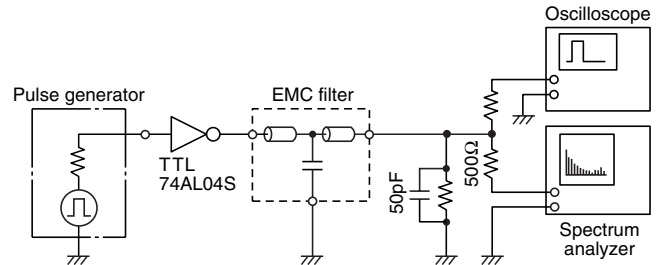

PULSE WAVEFORM

WITHOUT EMC FILTER

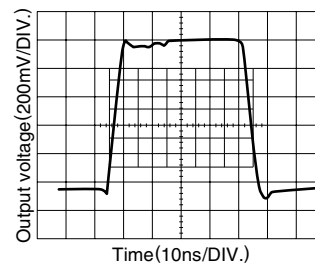

WITH EMC FILTER

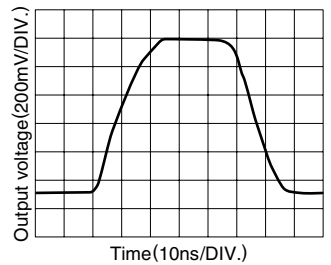

(2) MEASUREMENT RESULTS

(a) SPECTRUM WITHOUT EMC FILTER

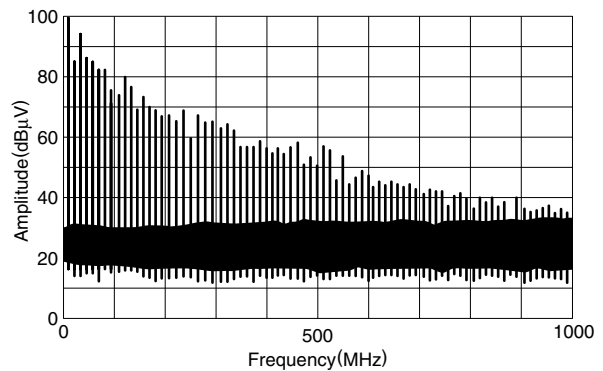

(b) SPECTRUM WITH EMC FILTER

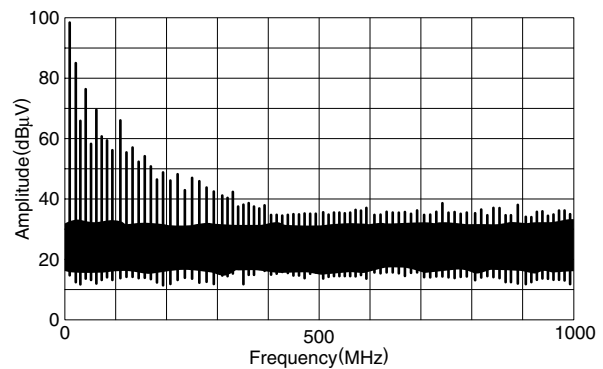

EMC Components

ZJSR Series

3-Terminal Filters for Signal Line and DC Power Line Lead(Round)

AN EXAMPLE OF MEASURING NOISE SUPPRESSION EFFECT (Radiation spectrum)

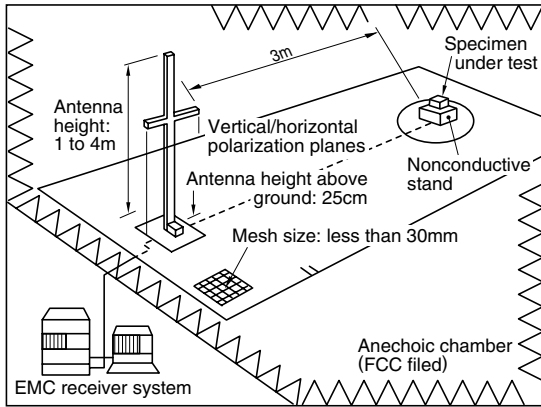

RADIATION LEVEL (a)WITHOUT EMC FILTER

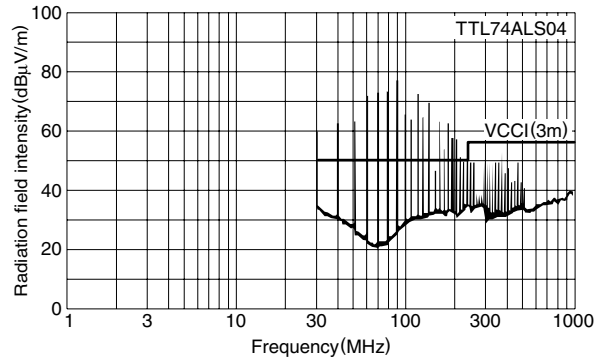

(b)WITH EMC FILTER

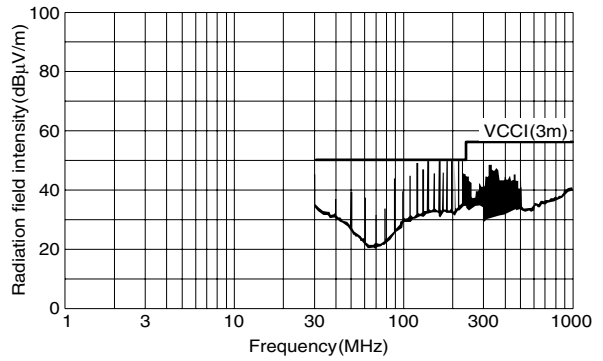

TTL OUTPUT WAVEFORM WITHIN A SHIELDING CASE

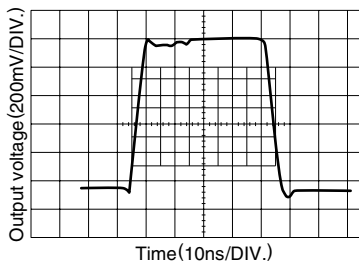

MODEL

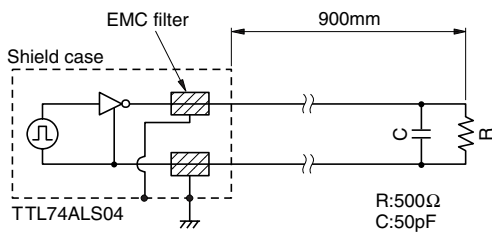

BICONICAL ANTENNA INDUCED WAVEFORM

